

CMD
MFD/12.23

Manifold Block for DC Valve 06 Size type MFD



Replaces : MFD/11.11

Features :

- Compact Design
- Ground & Blackened Surface
- Available in 1 to 4 stations (As required by Customer)

Technical data (for other specifications, please contact mktg@cmhydraulics.com)

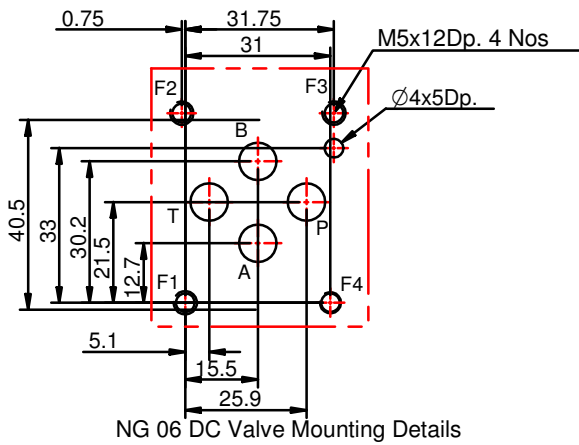
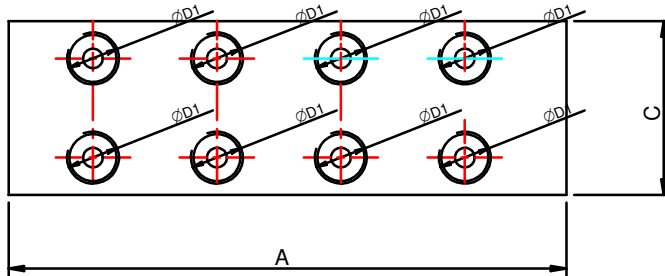
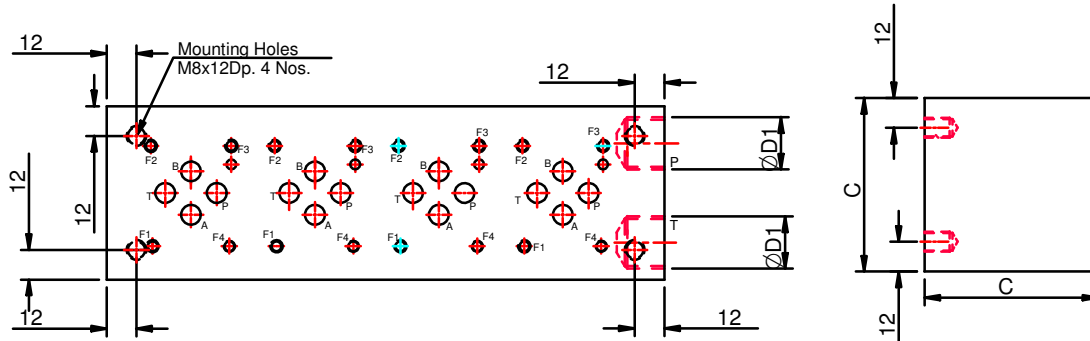

NG 06 DC Valve Mounting Details

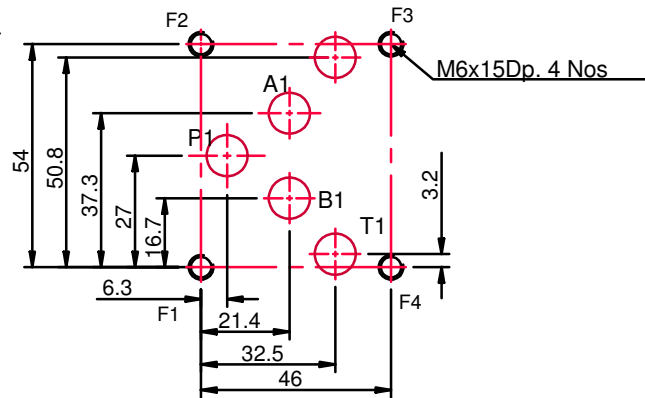

NG 10 DC Valve Mounting Details

No. of Stations	01	02	03	04
A	70	125	175	225
C	70	70	70	70
$\phi D1$	1/2" BSP			

NG 06 Manifold Block Details

No. of Stations	01	02	03
A	125	225	325
C	110	110	110
$\phi D1$	3/4" BSP		

NG 10 Manifold Block Details

CMD
MFD/12.23

Manifold Block for
DC Valve 06 Size type MFD



Replaces : MFD/11.11

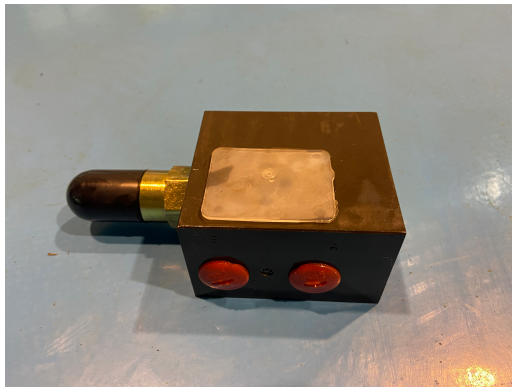

Ordering Code

CMH	MFD	1	06	01	*
-----	-----	---	----	----	---

Manifold for DC Valve

=MFD

Further details to specify

1 No. Station	=1
2 Nos. Station	=2
3 Nos. Station	=3
4 Nos. Station	=4

01 =	Steel
02 =	Cast Iron

06 =	NG 06 Size
10 =	NG 10 Size

CMD
MFU/11.11

Manifold Block for Unloading type MFU



Features :

- Compact Design
- Ground & Blackened Surface
- Available in 6 & 10 Sizes.

Technical data (for other specifications, please contact mktg@cmhydraulics.com)

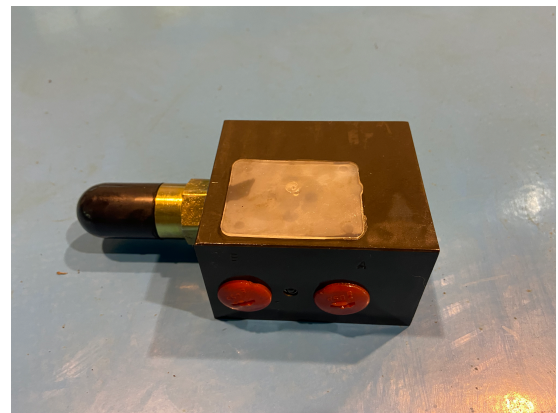
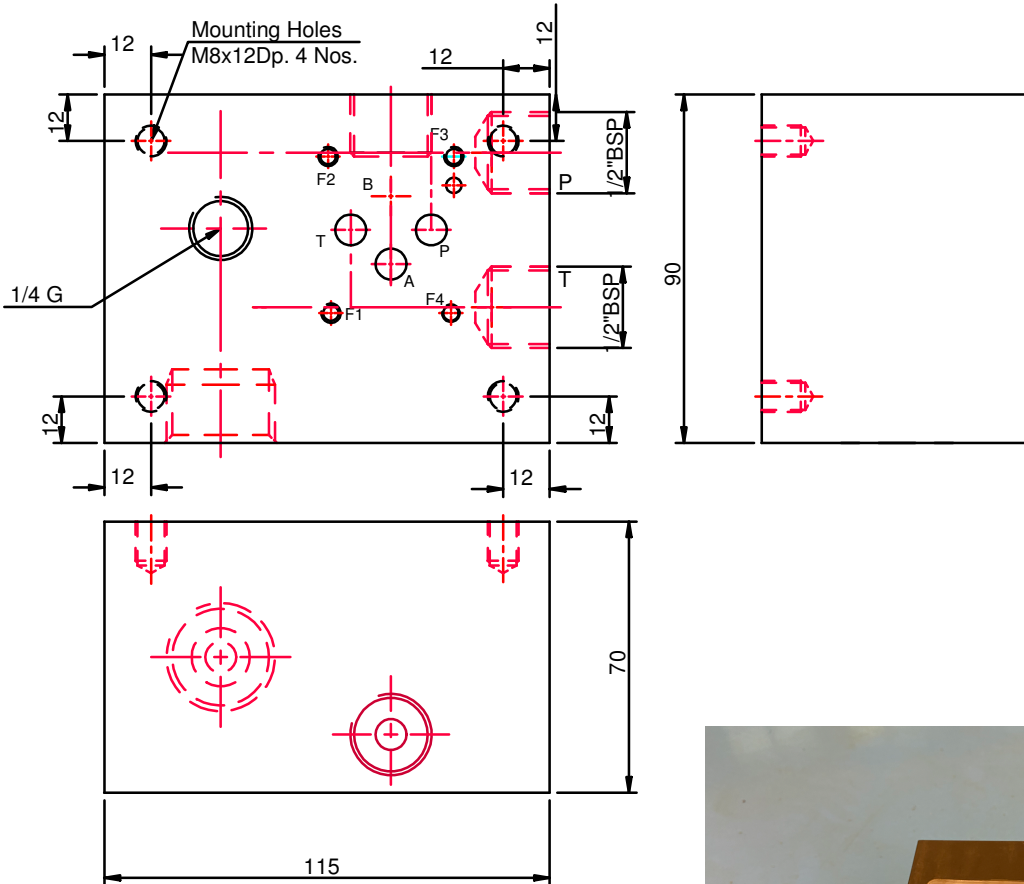

Ordering Code

CMHMFU 06 1 *

Manifold for Unloading

=MFU

NG 06 Size
NG 10 Size

=06
=10

Further details to specify

0 = With out DC Valve
1 = With DC Valve